

Raymond Franklin Bieber

Email: raymondbieber@rocketmail.com

Website: www.raymondbieber.com

Vimeo Page: <https://vimeo.com/user88901586>

Demo Reel: <https://vimeo.com/394053982>

4913 New England Lane Sylvania, OH 43560,

Phone: (734)2181425

Raymond Bieber graduated from the University of Toledo with a Bachelor of Fine Arts major with a concentration on New Media Design Practices and a minor in Art History. He graduated from Whiteford High School in Ottawa Lake Michigan. He discovered his passion for photography and design while on the high school yearbook team. He has experience with photography and page layout. He has worked with Photoshop, Illustrator, Dreamweaver, InDesign and After Effects. He has collaborated with his colleagues to develop murals and posters for the Toledo Museum of Art and its library and the University of Toledo engineering building. He is now an Art Teacher at Skyway Career Prep High School.

Resume

Education

- University of Toledo**, Toledo, OH Aug. 2016-May 2020
- Bachelor of Fine Arts in Visual Arts with a minor in Art History.
- Whiteford Agricultural School**, Ottawa Lake, MI Sept. 2002-June 2016

Employment

- Skyway Career Prep High School**, Toledo, OH Oct 2023-Present
- Art Teacher: Mixed Media, Graphic Design, and Photography.
- Beluska Graphics Inc**, Perrysburg, OH July 2022-Oct 2023
- Layout catalogs for each client in InDesign.
 - Prepare artwork in Illustrator.
 - Edit images in Photoshop.
 - Finalize PDFs in Acrobat.
- American Frame**, Maumee, OH August 2021-July 2022
- Print images for matting and mounting.
 - Photograph art and edit images for reproductions.
 - Enter orders into computer and color fill frames.
 - Assist in other departments as needed.
- Costco**, Toledo, OH August 2020-August 2021
- Adams Street Publishing**, Toledo, Ohio Jan. 2020-May 2020
- Create advertisements using InDesign.
- Toledo Journal**, Toledo, Ohio April 2019-Aug. 2019
- Edit images in Photoshop.
 - Layout pages in InDesign.

Awards/Activities

- Art Student League**, University of Toledo Sept. 2016-May 2020
- Helped gather supplies for Halloween party.
 - Volunteered at Momentum festival to sell shirts for Art Student League.
- Photographers Forum Best of College and High School Photography**, 2018
- Finalist
- University of Toledo Spring 2020 BFA Thesis Exhibition**
- Participant
- Red Bird Art District**
- Volunteered to take photographs and video at First Friday Art Walk and Farmers Market 2021

Skills

- Working with others
- Self-Motivated
- Willing to learn new skills
- Microsoft Office
- Adobe Suite
- Photography
- Editing

Interests

- Reading
- Gaming
- Music
- Movies
- Museums

Beluska Graphics Inc.

I used Illustrator to break apart to original design to fit it for the 8 1/2 x 11 format. I also included the dashed lines to show how the pieces go together. I then placed the numbers for the parts list. This was challenging because the numbers could not change size while the drawing was now smaller.

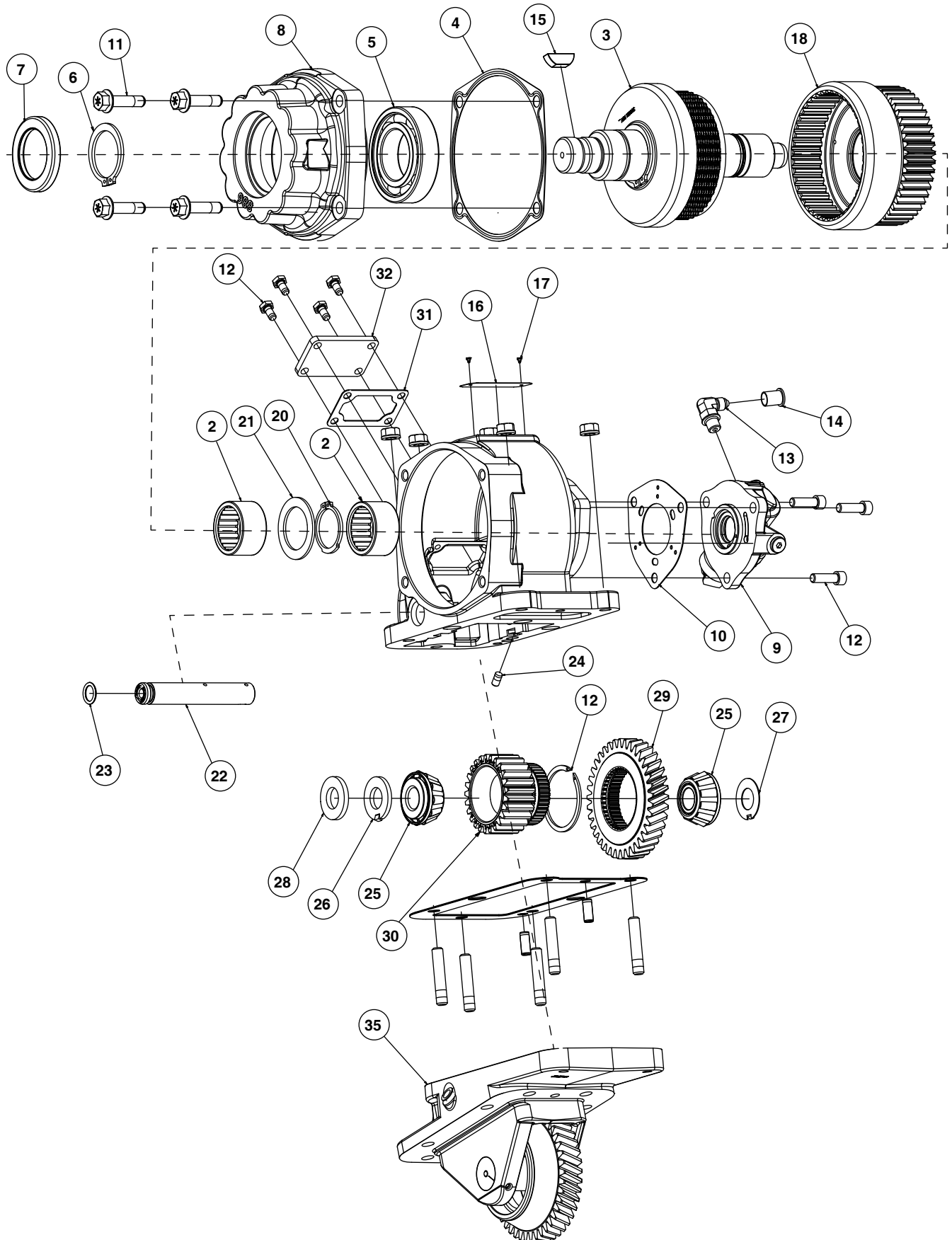

I used Illustrator to layout the bubbled text and to format the color for CMYK black. The following page is the finished page with the corresponding table designed in InDesign. The scaling had to be consistent and the bubbles could not change size.

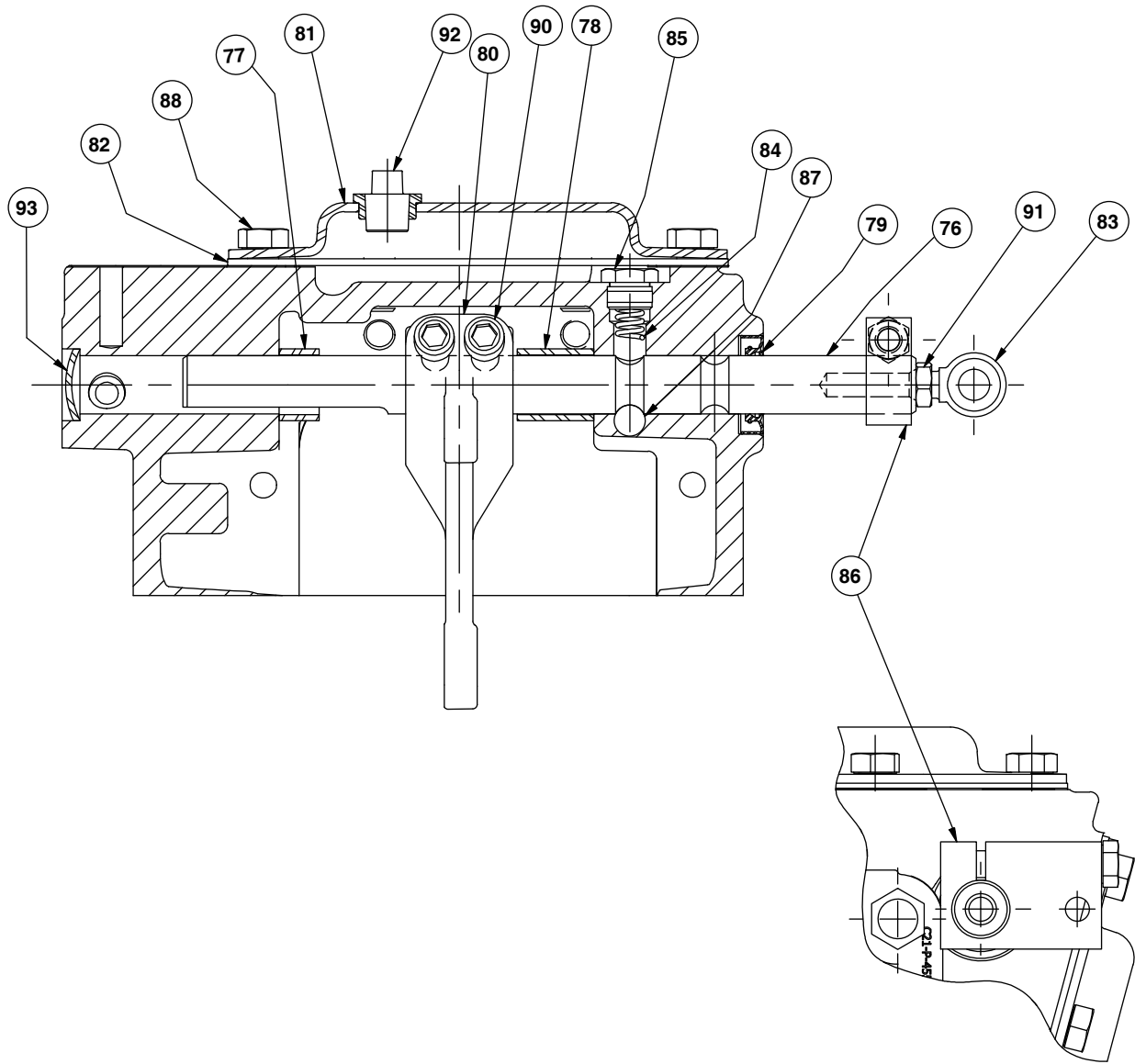

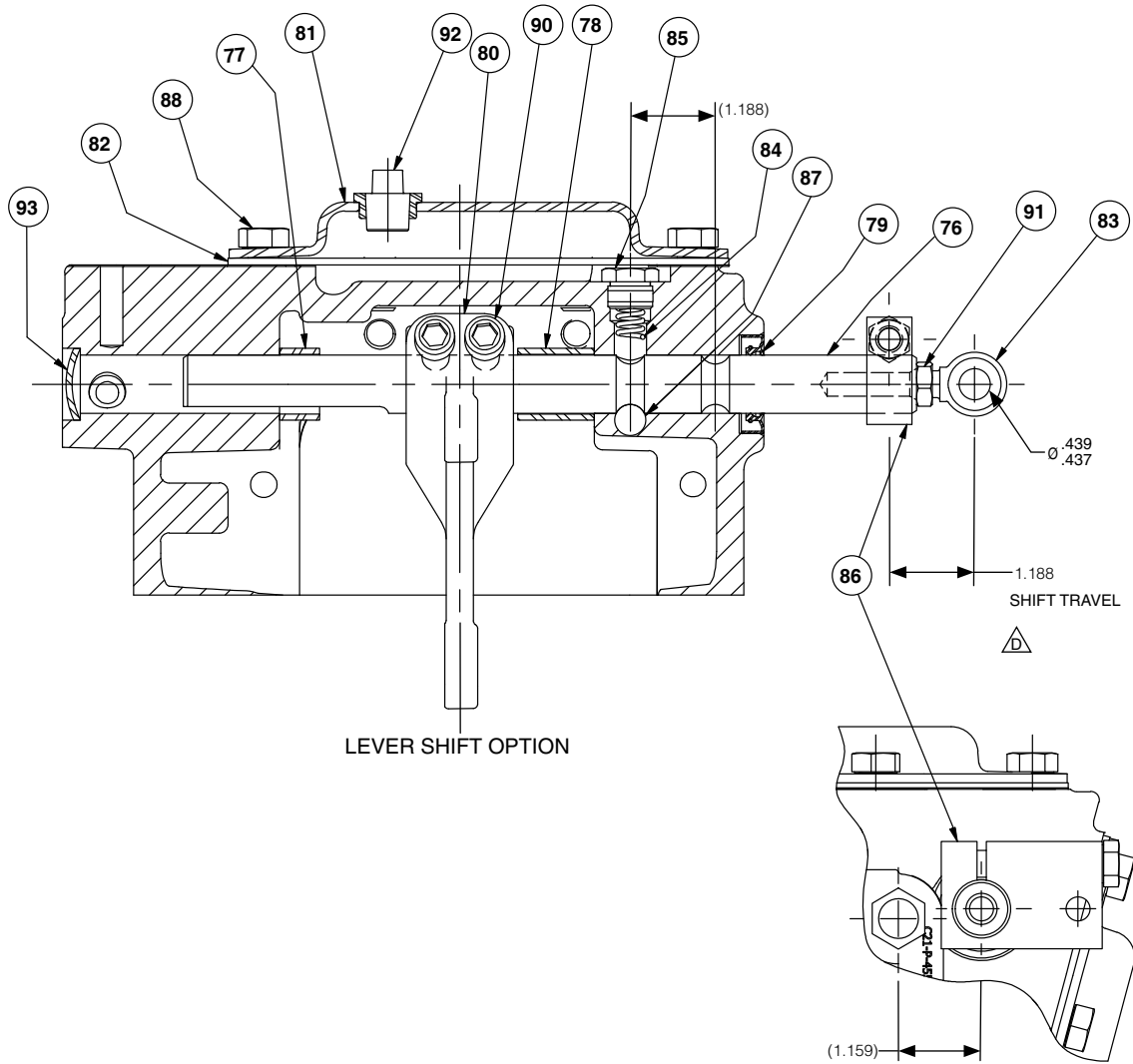

ITEM	PART NUMBER	DESCRIPTION	QTY.
76	11-P-150	Shifter Shaft (.81") (Lever Shift Only)	1
77	12-P-19	Sleeve (.834" x 1.005" x .560") (Lever Shift Only)	1
78	12-P-20	Sleeve (.834" x 1.005" x 1.067") (Lever Shift Only)	1
79	18-P-218	Oil SEAL (1.379" x .812" x .312") (Lever Shift Only)	1
80	32-P-171	Shifter Fork (Lever Shift Only)	1
82	35-P-32	Cover Gasket 8-Bolt (Lever Shift Only).....	1
83	36-P-1	Eye Bolt-3/8-24 (Lever Shift Only)	1
84	37-P-41	Spring (.406" x 1.125") 6-Bolt (Lever Shift Only)	1
85	38-P-6	Poppet Cap (Lever Shift Only).....	1
86	329133X	Shifter Shaft Extension Assembly (Lever Shift Only).....	1
88	378432-9	Hex. Capscrew (.438-14 x .875) (Lever Shift Only)	8
90	379433-8	SH Capscrew (.375"-16 x 1.500") (Lever Shift Only)	2
91	500381-3	Hex Jamb Nut (.375"-18) NPTF (Lever Shift Only)	1
92	500113-3	Pipe Plug (.375"-18) NPTF (Lever Shift Only)	1
93	500166-14	Welch Plug 1 (Air & Lever Shift)	1

Freelance Design

I designed this flyer for a local artist. She supplied the pictures and text. I made an earlier rendition to discuss with her before making this final version entirely in InDesign.



This was designed for the Link Engineering. I measured the panel and created a template in Illustrator to include the holes in the panel. I used this temple to create my designs.



This was designed for the Costco in Toledo Ohio. They made a newsletter that was about this store specifically. I designed the cover for it in Illustrator.



ONE DOUBLE OH SEVEN

All Departments • Articles By Team Members • All About Your Warehouse • Exclusive Information • Made For You!

Personal Projects

This piece is part of my series that deals with the way rural and urban life impact each other. This untitled piece is about the issue of rural land being bought up for urban development with the money being tempting to most farmers that struggle financially. This was designed in Illustrator.



Personal Projects

This is a personal project. I was not sponsored, paid, or associated with the Coca-Cola company when I made this. This was made using Illustrator and InDesign.



This is a personal project. I was not sponsored, paid, or associated with PepsiCo when I made this. This was made using Illustrator and InDesign.

BRING THE COOL ONE

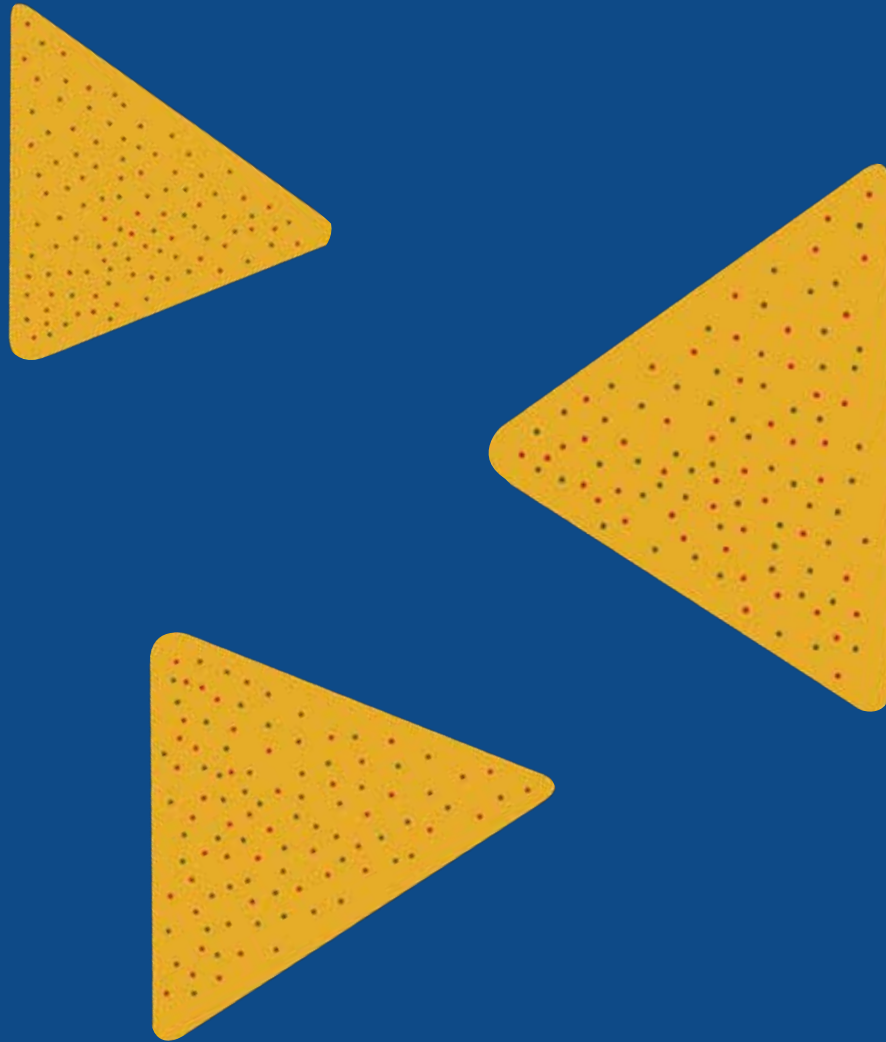

BE THE COOL ONE

Book Cover Design

This is the cover for the book I made of all of my works in college for the BFA Thesis course. I designed the cover and book in Indesign. The book can be viewed [here](#).



Toledo Museum of Art Collaboration

I collaborated with my colleagues on this design for the poster for an exhibition at the Toledo Museum of Art. I was in charge of this version to be posted on Facebook



Adams Street Publishing

These are advertisements that I designed for Adams Street Publishing. They were made in InDesign while some images are edited in Photoshop. I have designed advertisements meant for digital and for print.



STONE SCHOOL
COOPERATIVE
PRESCHOOL

OPEN HOUSE:
Thursday, Mar. 19th
6-7pm
Saturday, Mar. 28th
11am-1pm

SUMMER CAMP PROGRAM

WE ARE OFFERING 9 DIFFERENT WEEK LONG SESSIONS.

All Camp Sessions are for 3-7 year olds on M-F mornings.

9 SUMMER CAMP SESSIONS
Jun. 1st - Aug. 7th

2811 Stone School Rd. Ann Arbor, MI 48104
For more information visit our website at
www.StoneSchool.org • 734-971-4820

GIVE YOUR CHILD THE GIFT OF A HEALTHY SMILE



DR. JESSICA PERRY HAS JOINED US!

Poorly aligned teeth can lead to dental problems. Achieving your child's healthy beautiful smile is a team effort involving an orthodontist, your dentist and other dental specialists.

*Call today to schedule a complimentary consultation
Open four days a week!*



2019 WINNER

Kelly Orthodontics

1245 Industrial Drive
Saline, MI 48176
734.429.7676





invisalign PROVIDER



DIPLOMATE, AMERICAN BOARD OF ORTHODONTICS



Member American Association of Orthodontists

Sylvania Pediatric Dental Care
Your Child's Dental Home



VOTE FOR US!

Specialists in comprehensive dental care for infants through teens

Sylvania Pediatric Dental Care is a leading pediatric dental practice located in Sylvania, Ohio. Superior oral health is vital for a child's development, and we're here to help every step of the way! When you visit our pediatric dental office, your smile is our top priority. Our entire team is dedicated to providing children with the personalized, gentle care that they deserve. We will submit to most dental insurance plans and can work with you to make treatment affordable.

Call us today

5860 Alexis Road, Sylvania, Ohio 43560
419-882-7187

contactus@syvianpediatricdentalcare.com • syvianpediatricdentalcare.com • Find us on Facebook

BIGGEST STORE IN TOLEDO!

BIGGEST SELECTION PRICE MATCH EVEN AMAZON OVERALL
30 YEARS EXPERIENCE KNOWLEDGEABLE STAFF



- ORGANIC NUTRIENTS
- SOIL
- HYDROPONIC GARDENING
- AIR PURIFICATION
- LIGHTING & ACCESSORIES
- PUMPS & IRRIGATION
- AND MUCH MUCH MORE!



WHEN YOU'RE GROWING SEASON NEVER ENDS WE ARE YOUR HOBBY LOBBY TO YOUR COMMERCIAL GROWERS!

WE CARRY CBD!
Show potential for:

Pain Relief	Overcoming PTSD
Reducing Inflammation	Reducing Acne
Reducing Nausea	Treating Seizures
Reducing Anxiety	Reducing Blood Pressure
Reducing Depression	

Hemp is legal in all 50 states • Non-narcotic



IT'S TIME!! Starting your seeds for your outdoor Gardens. We supply tents, lights, and all the nutrients and soils. While harvesting, we can walk you through the important steps of curing your vegetables and herbs properly and can supply you with the necessities needed for this.

5520 Secor Rd. | Toledo, OH | 419.725.2450 | ToledoIndoorGarden.com
Across the street from Brondes Ford

Toledo Journal

These are pages that I designed for the Toledo Journal. I edited the images in Photoshop and laid out the pages in InDesign. I worked with the editor to make revisions as needed.

Education

Mecca Temple 43 gives away 27 bikes during Shrine Day



The Nobles of Mecca Temple 43 stand behind the winners of the bikes during their annual Shrine Day.

BY JERRY TALBIDEN, Journal Staff Writer
During their annual Shrine Day, Mecca Temple 43 gave away 27 bikes to children who had won a raffle. The bikes were given away during their annual Shrine Day.

children would be given a raffle ticket, and then they would simply stand behind the bike they wanted. A number would be read off, and the winner simply takes home a bike, compliments of Mecca Temple 43.



Noble Sherrard Ramsey gives out the raffle tickets to the parents, and their kids, just prior to the drawing.

Day on Saturday, July 20, for the children, five of the members of Mecca Temple 43 provided a bouncy house for the children.

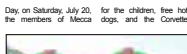

Mecca Temple 43 provided a bouncy house for the children.



Club of Toledo displayed game away 27 bicycles to the children. The annual event celebrates the children getting a bike, members enjoy the Shrine.

Club of Toledo displayed game away 27 bicycles to the children. The annual event celebrates the children getting a bike, members enjoy the Shrine. Simultaneously, the event. He led the continuing the charitable

to buy my kids bikes, then I found about this event. I can be easily having to buy bikes for three kids that is why I really appreciate what the organization did today. In addition to their annual bike giveaway, during Shrine Day, Mecca Temple 43 also sponsors free haircuts, works with Martin Luther King Academy for Boys, donates to the Mid-City Reds football team, the City Park Basketball League, and gives out three scholarships during their annual Patriotic Ball. Robert Ramsey, Illbruck Poterata, said not only was he glad to do a service for the community, but he thanked the Nobles who showed up for the event, and thanked the Daughters of Mecca Court 25.

PHOTO CREDIT: TOLEDO JOURNAL

Education/Aparently

What We Can Learn from Schools that Educate Military Children

by NNPA/ESSA Family Liaison, Education, ESSA, Every Student Succeeds Act, Every Student Succeeds Act (ESSA). Featured: K12 Public Schools, K12 Education, NNPA, NNPA News, nnpa/ESSA, Virginia | 0 comments

Dr. Elizabeth Primas, NNPA/ESSA Awareness Campaign Program Manager

It is not uncommon for military programs to be adopted for use in civilian life. Schools in Virginia Beach, VA, that have some of the highest percentages of military children in the country are doing an incredible job helping those students cope with the added stresses of having parents in the military. Other schools and communities can learn from Virginia Beach City Public Schools, which recently spent a day with families and educators from Shelton Park Elementary School. About 20 students there were

children with a parent in the military or a defense contractor. There is a large population of special forces personnel in Virginia Beach. One mother we spoke with said her daughter is school knowing that the school community would play an active role in engaging with her to

include 26 Military Family Liaison Officers, who work closely with school staff and families to support students. One mother we spoke with said her daughter is school knowing that the school community would play an active role in engaging with her to

of having a parent deployed where Virginia Beach schools excel in supporting this population of students. A questionnaire that Virginia Beach schools and districts with high percentages of military families are supporting students who on average are exposed to art, music, reading, and writing. The Virginia Beach schools' well-rounded curriculum combined with support educational programs, and creates a school achievement. However, moving is not the only thing that can disrupt educational progress. Low teacher retention, frequent absenteeism, and unsafe school environments are all factors that can also inhibit academic progress.

The Every Student Succeeds Act, a federal education law, requires schools and districts to have a well-rounded curriculum. Too many schools have eliminated music, art, drama, and essential academic courses like social studies and science to save more instruction time.



Dr. Elizabeth Primas spoke with, talked about the fears her five-year-old daughter had while her father was deployed. After a particularly bad night, the mother let the school staff and the assigned counselor know that her daughter was going through a very difficult time. However, help her work through her fears. The Virginia Beach schools and districts to have a well-rounded curriculum. Department of Defense, learned and specialized in child and youth behavioral issues. It's not just supporting students through the stress

From the very beginning, students at Shelton Park Elementary School are exposed to art, music, reading, and writing. The Virginia Beach schools' well-rounded curriculum combined with support educational programs, and creates a school achievement. However, moving is not the only thing that can disrupt educational progress. Low teacher retention, frequent absenteeism, and unsafe school environments are all factors that can also inhibit academic progress.

Dr. Elizabeth Primas is the ESSA Program Manager for the National Newsletters Publishers Association.

The Test Every Kid Needs Before Going Back to School

(StatePoint) Before Edward Rossi Eye Institute, what's more, kids have more attention on their eyes and vision than ever before due to the increased use of digital devices.

To help ensure a smooth transition back to school, consider the following tips and insights:

Get a Comprehensive Eye Exam While 70 percent of parents said sight is the most important concern, 50 percent take their kids for an annual eye exam according to a recent survey conducted by YouGov and VSP Vision Care, almost 200,000 children, with many parents under 40 years old.

The incidence of usual eye issues in preschool children is expected to increase 20 percent over the next 40 years, according to a recent study by the USC Gayle and Eye Exam.

While 70 percent of parents said sight is the most important concern, 50 percent take their kids for an annual eye exam according to a recent survey conducted by YouGov and VSP Vision Care, almost 200,000 children, with many parents under 40 years old.

The incidence of usual eye issues in preschool children is expected to increase 20 percent over the next 40 years, according to a recent study by the USC Gayle and Eye Exam.

Northwest Ohio is POWERED

CARED for **BUILT** **EDUCATED**

Theresa Hanks, RN, DNP, 12 years of experience in nursing

Pat Spivey, RN, DNP, 12 years of experience in nursing

APRIL KENNEDY, RN, DNP, 12 years of experience in nursing

BY the proud alumni of OWENS COMMUNITY COLLEGE.

More than 70% of Owens alumni choose to live and work in our community.

Your Success Starts Here Fall classes begin August 28. OWENS.EDU

Auto/Sports

The Toledo Threat captures the title in 'Quest for the Best' Smothering defense gives them 31pt win



Shaaree Ullis dives on the floor to help cause a turnover.

BY JERRY TALBIDEN, Journal Staff Writer
Toledo Threat led to the lead heading into the second quarter, with a score of 21-16.

Within the opening minutes of the second quarter, Raven Ferguson would give the Threat their first lead, making it 22-21.

University, 6822 Convent Blvd., Sylvania, Ohio, on Saturday, August 3, and Sunday, August 4.

The Toledo Threat, The Atlanta Monarchs, and the Philadelphia Reign, who were the best teams in the league.

Thursday night featured the number two team, Toledo Threat with a record of 9-1.

The Atlanta Monarchs, with a record of 7-1. The Threat would prevail in high scoring overtime victory of 95-88.

The very next day, who led the Threat would face the number one ranked Philadelphia Reign, who came in with an unblemished record of 10-0.

The first quarter would belong to the Reign who seemed to do everything correctly, from scoring to defense to rebounding, everything favored the Reign.

The Threat would find themselves down

nonexistent as the Threat trailed to a 10-7 lead. "We were a little tired from yesterday's game, but the substitutions, with fresh legs helped us out a lot," said Raven.

Rachel Theriot, the MVP of the game, although I was awarded, it really belongs to all of us. I couldn't have accomplished anything without my teammates, so this MVP belongs to the team."

For Shaaree Ullis, who has been a part of the Threat since their establishment, three years ago, the championship game would be her last. "I'm 30 years old, and it's time for me to retire. I've loved being a part of this organization, and it feels good to win the championship," she said.

PHOTO CREDIT: TOLEDO JOURNAL

I'M BACK AND I HAVE A DEAL FOR YOU!

GOOD CREDIT? BAD CREDIT? NO CREDIT? FIRST TIME BUYER?

CARS PRICED TO SELL

2017 DODGE CHARGER RT BURG/BLK, HEIM, LOW MILES REALLY SHARP!

2016 CHRYSLER 300 S CHARG/BLK, LOW MILES READY TO ROLL!

BY the proud alumni of OWENS COMMUNITY COLLEGE.

More than 70% of Owens alumni choose to live and work in our community.

Your Success Starts Here Fall classes begin August 28. OWENS.EDU

Education/Aparently

Imagine Madison Avenue School of the Arts Named 2019 Ohio School of Character

For over 20 years, Schools, a national non-profit network of public charter schools, announced its Imagine Madison Avenue School of the Arts in Toledo, Ohio, Character, a rigorous application and review process by must demonstrate Schools that apply for recognition as a State School of Character benefit from self-assessment as well as the expert feedback they receive through the evaluation.

The process of applying, receiving feedback, and technical assistance creates a path for excellence for the participating schools. This designation as a State School of Character reflects a schoolwide commitment to helping students become excellent learners and leaders," states Principal Lindsay Day. "We are honored by this recognition."

Janelle Washington, a parent at Imagine Madison, states: "The teachers create a path for excellence for the participating schools. This designation as a State School of Character reflects a schoolwide commitment to helping students become excellent learners and leaders," states Principal Lindsay Day. "We are honored by this recognition."

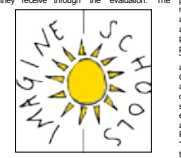

Great Reading Ideas to Inspire Young Students

(StatePoint) A new school year means new classes, new teachers and new schedules. At home, you can find out about program by planning a scavenger hunt, and discover how fun it can be with different subjects. To turn these new ideas into fun, consider the following:

- **Only coding** for kids with a potential interest in computers and coding.
- **Inspiring true stories:** Consider 'How to Be a Code Ninja' kids can discover the inspiring story of Jane Goodall, a pioneer of primateology

like computer scientists in no time. Learn about the secret world of friendship bracelets, find out about program by planning a scavenger hunt, and discover how fun it can be with different subjects. To turn these new ideas into fun, consider the following:

- **Only coding** for kids with a potential interest in computers and coding.
- **Inspiring true stories:** Consider 'How to Be a Code Ninja' kids can discover the inspiring story of Jane Goodall, a pioneer of primateology



Northwest Ohio is POWERED

CARED for **BUILT** **EDUCATED**

Theresa Hanks, RN, DNP, 12 years of experience in nursing

Pat Spivey, RN, DNP, 12 years of experience in nursing

APRIL KENNEDY, RN, DNP, 12 years of experience in nursing

BY the proud alumni of OWENS COMMUNITY COLLEGE.

More than 70% of Owens alumni choose to live and work in our community.

Your Success Starts Here Fall classes begin August 28. OWENS.EDU

Data Visualization

These are stills from my data visualization piece. You can watch the video by clicking [here](#). I create the elements in Illustrator and animate them in After Effects.

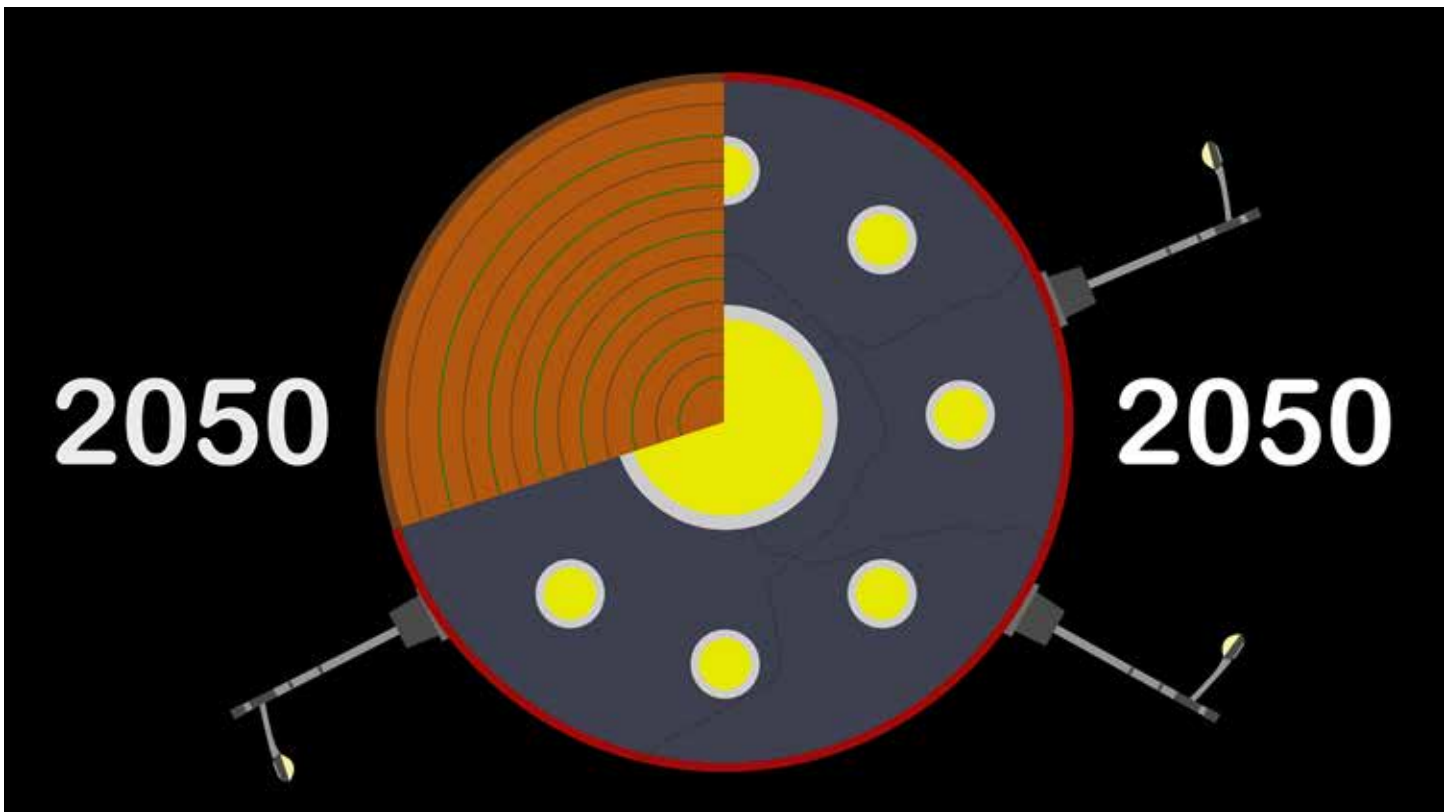
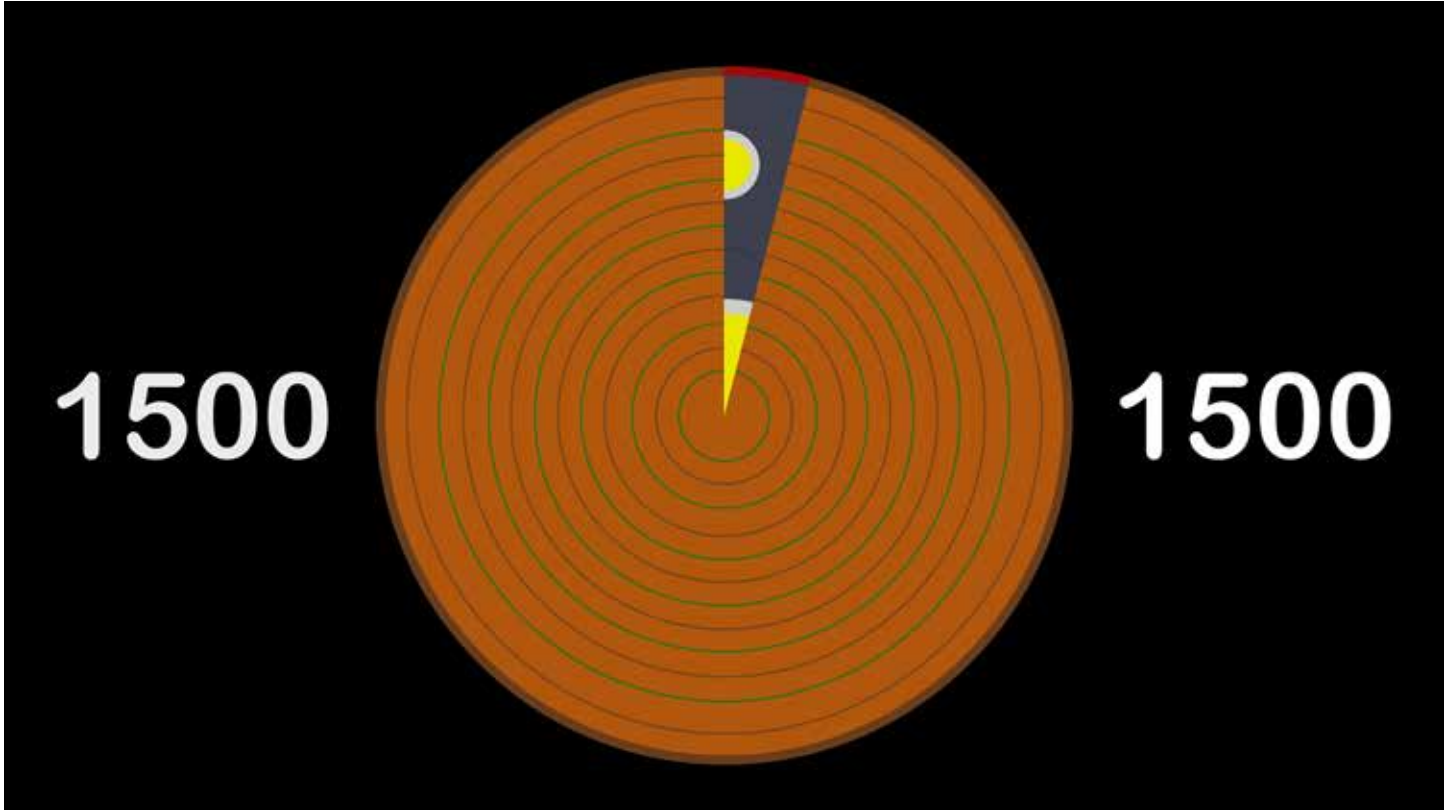

Animations

These are stills from animations that I made. I created all of the pieces in Illustrator and animate them in After Effects. To add sound I place the video into Premiere Pro and re-encode. The Animations are on my Vimeo page which is linked up top.



Game Design

These are stills from a game that I made. I created all of the pieces in Illustrator and coded the game in Unity. You can play it by clicking [here](#).

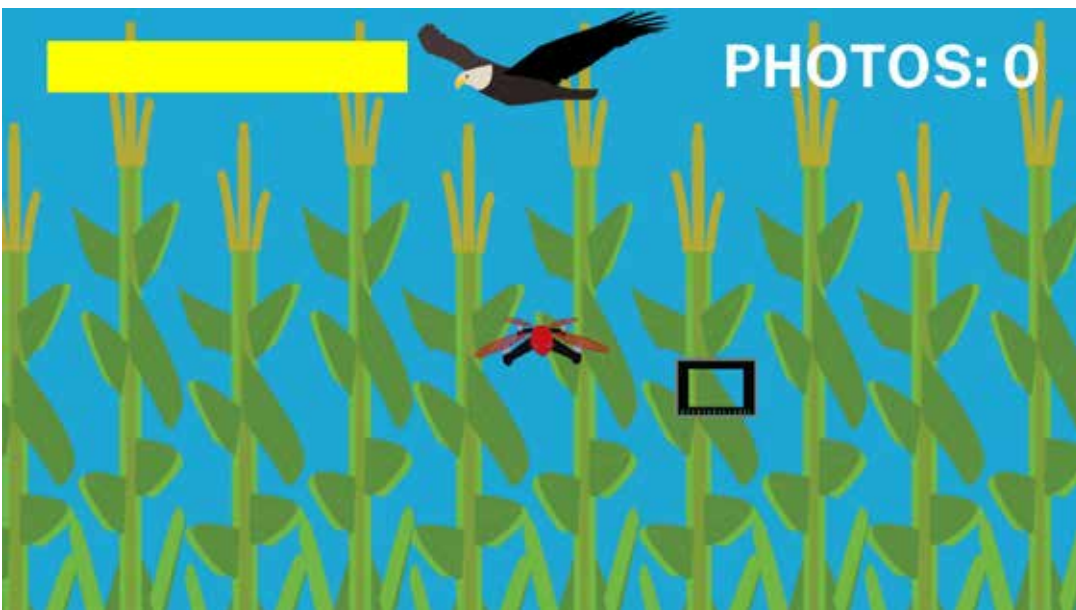
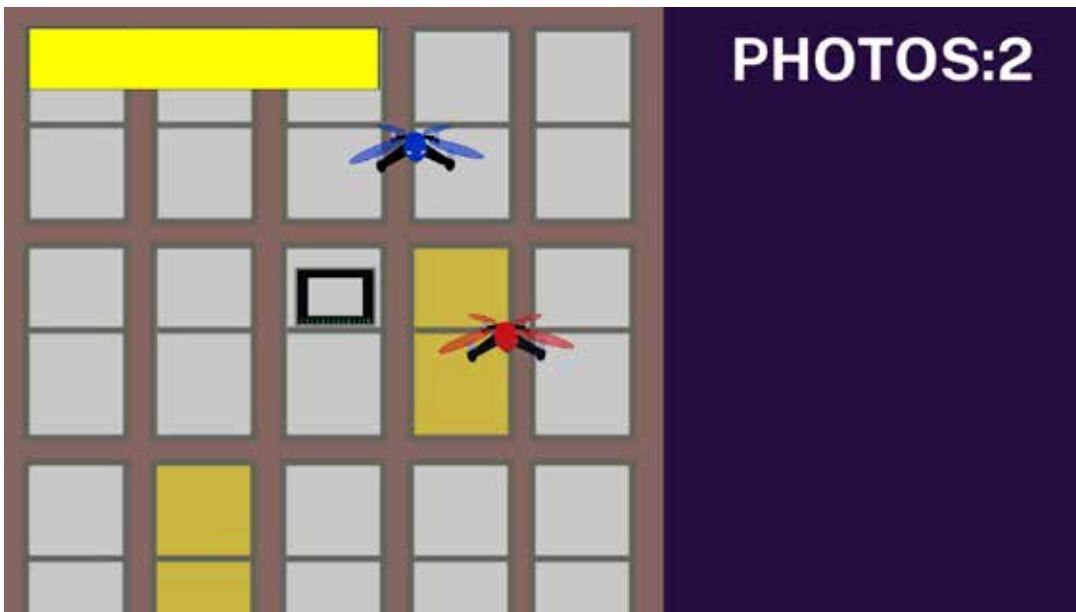
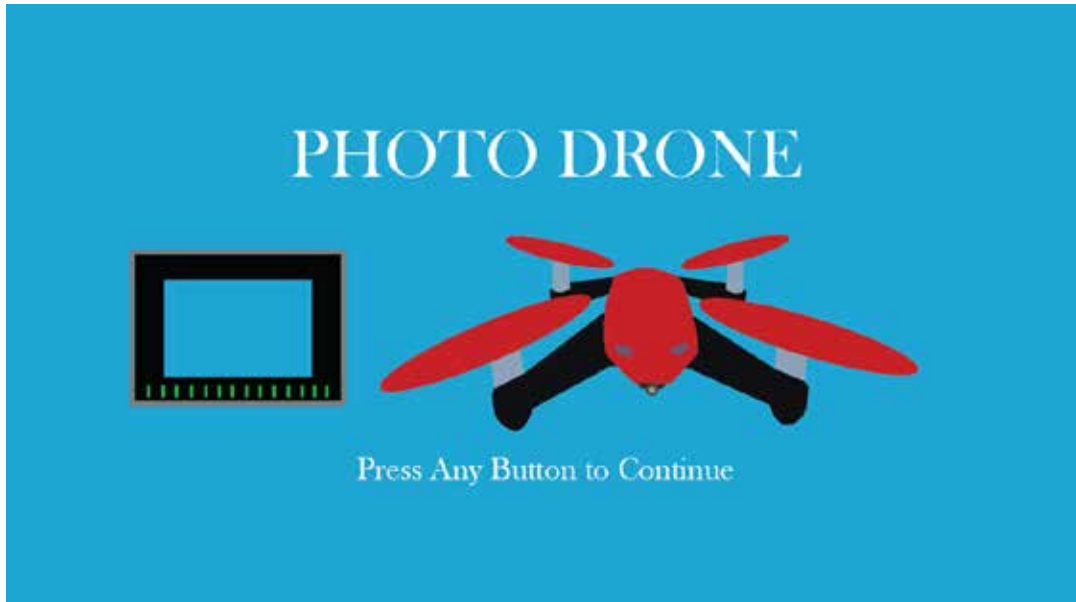

Freelance Photography

These are photographs I took for Sautters in Sylvania OH.

